

Krusman

Emergency Showers



PRODUCT CATALOGUE

Krusman Emergency Showers is one of Scandinavia's leading suppliers of emergency showers and eye- and facewashes. We share our knowledge about equipment and regulations with our customers and provide them with risk measurements.

We ensure safety in risky environments.



Table of contents

Page

About Krusman Emergency Showers	2
Eye- and facewashes	3 - 6
Portable eyeshowers	7
Emergency showers	9 - 10
Safety stations	11 - 12
Safety stations with mixing valves	13 - 16
Emergency showers for hot & cold climates	17 - 20
Emergency shower booths	19
Tank showers	19
Alarms	21
Options and accessories	23 - 24
Packing for transport - dimensions	25 - 26

Our knowledge - your guarantee for safety

Krusman Emergency Showers is one of Scandinavia's leading suppliers of emergency showers and eyewashes.

We share our knowledge about equipment and regulations with our customers and provide them with risk measurements.

Our main objective is to save lives.

About us

Krusman Emergency Showers is a well-established family business which started with Lennart Krusman selling emergency equipment in the early 70ies. Today the company is run by his son, Daniel Krusman.

We have more than 30 years of experience within the safety and health area and deliver emergency showers to Scandinavia, Central Europe and Middle East among others. We have been manufacturing our own products since 1986.

Our products comply with high quality standards and they meet the Swedish safety requirements as well as the quality demands in many other markets.

Laws and regulations have changed with time, and so have we.

We supply our products in line with our customers' needs

Different customers have different needs; therefore we produce our equipment in various materials and with different accessories. By doing so we can ensure that the equipment will function at its best in different environments. We offer eye- and facewashes, emergency showers and decontamination booths. Our product range also includes unique portable eyeshowers for indoor and outdoor usage as well as inside vehicles.

All our products are manufactured in accordance to ANSI Norm Z 358.1-2009 and EN 15154-1 & 2:2006. Any product can be ordered for EX-classified environments.

Emergency showers and eyewashes are necessary in the processing industry, chemical and food industry as well as refineries.

Our responsibility is to recommend the right emergency equipment for the right place at the right time.

Business idea

We ensure safety in risky environments through overall solutions and own-manufactured emergency showers.

Vision

We shall ensure safety in all conceivable risky environments.



• Model 3863

Krusman eyewash, wall mounted

Each individual spray head has built-in flow control and filter. Operated by a push plate, stay-open ball valve. The eyewash is self-draining. Complete with collecting bowl in powder-coated stainless steel, other details in chrome-plated brass. Working pressure: 2.4-6.5 bar.

Pictogram eyewash sign is included with each eye/facewash.

Flow rate (l/min)	Dimensions in mm (WxHxD)	Weight
14	400x195x353	3 kg

Options and accessories

- Alarm
- Foot pedal
- Thermostatic mixing valve
- Stainless steel

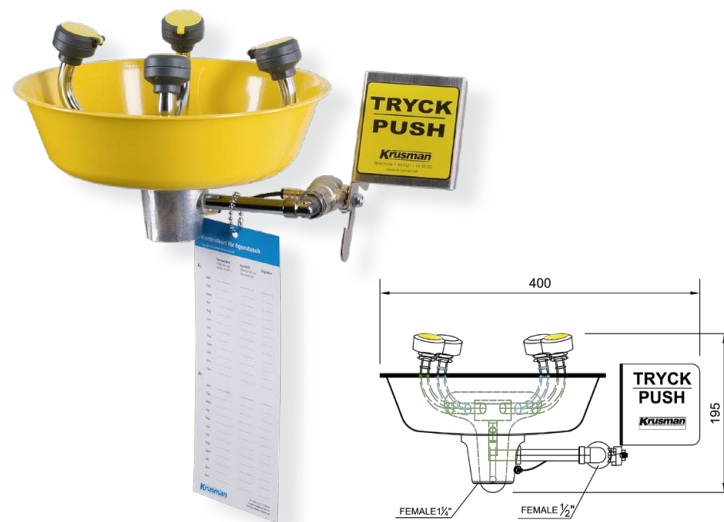

• Model 3864

Krusman eye- and facewash, wall mounted

Each individual spray head has built-in flow control and filter. Operated by a push plate, stay-open ball valve. The eye/facewash is self-draining. The placement of the spray heads gives both eyes and face washing. Complete with collecting bowl in powder-coated stainless steel, other details in chrome-plated brass. Working pressure: 2.4-6.5 bar.

Pictogram eyewash sign is included with each eye/facewash.

Flow rate (l/min)	Dimensions in mm (WxHxD)	Weight
28	400x195x353	3 kg

Options and accessories

- Alarm
- Foot pedal
- Thermostatic mixing valve
- Stainless steel

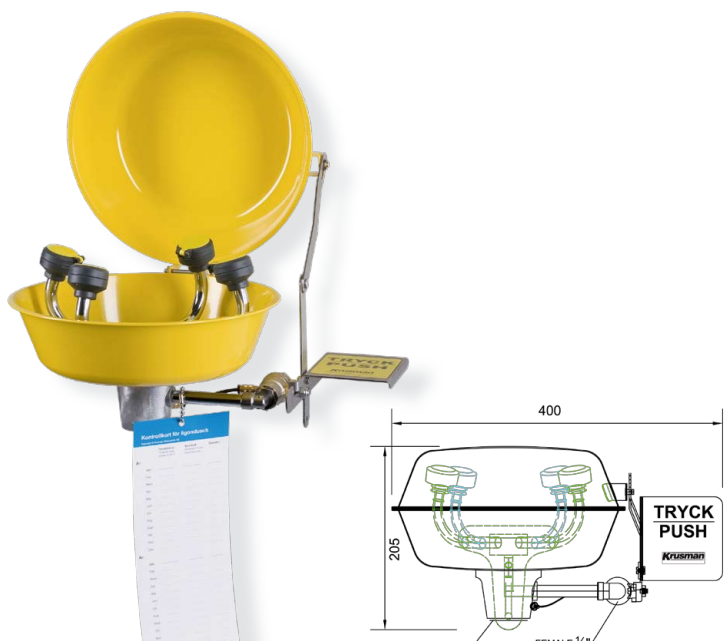

• Model 3866

Krusman eye- and facewash, wall mounted

Each individual spray head has built-in flow control and filter. Operated by a push plate, stay-open ball valve. The eye/facewash is self-draining. The placement of the spray heads gives both eyes and face washing. Complete with lid and collecting bowl in powder-coated stainless steel, other parts in chrome-plated brass. Working pressure: 2.4-6.5 bar.

Pictogram eyewash sign is included with each eye/facewash.

Flow rate (l/min)	Dimensions in mm (WxHxD)	Weight
28	400x205x353	3 kg

Options and accessories

- Alarm
- Foot pedal
- Thermostatic mixing valve
- Stainless steel

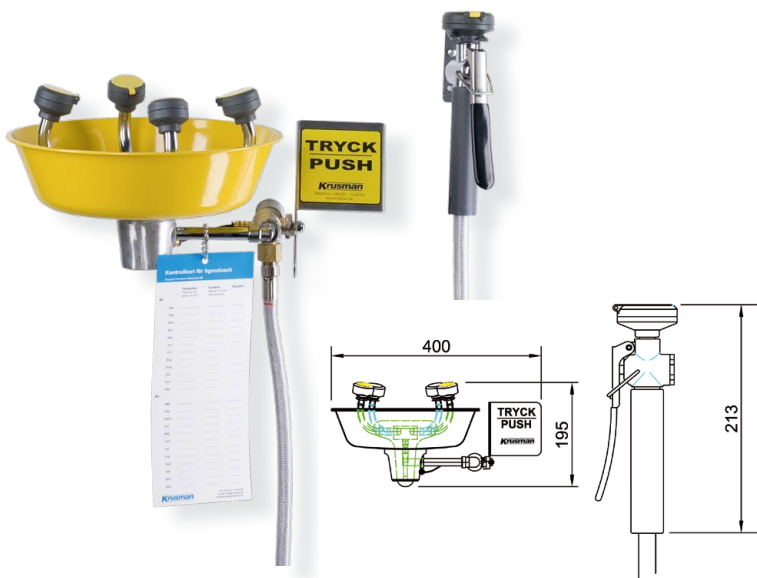

• Model 3867

Krusman eye- and facewash with drench hose unit

Each individual spray head has built-in flow control and filter. Operated by a push plate, stay-open ball valve. The eye/facewash is self-draining. The placement of the spray heads gives both eyes and face washing. Complete with collecting bowl in powder-coated stainless steel, other details in chrome-plated brass. Working pressure: 2.4-6.5 bar. Drench hose unit KN5025LC, 14 l/min, with built-in flow control and filter.

Pictogram eyewash sign is included with each eye/facewash.

Flow rate (l/min)	Dimensions in mm (WxHxD)	Weight
28+14	400x195x353	4,5 kg

Options and accessories

- Alarm
- Foot pedal
- Thermostatic mixing valve
- Stainless steel

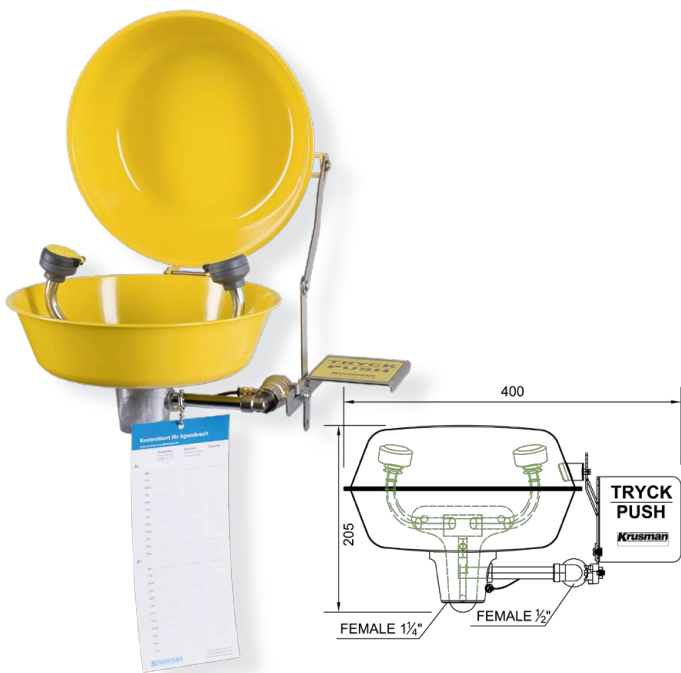

• Model 3868

Krusman eyewash, wall mounted

Each individual spray head has built-in flow control and filter. Operated by a push plate, stay-open ball valve. The eyewash is self-draining. Complete with collecting bowl and lid in powder-coated stainless steel, other parts in chrome-plated brass. Working pressure: 2.4-6.5 bar.

Pictogram eyewash sign is included with each eye/facewash.

Flow rate (l/min)	Dimensions in mm (WxHxD)	Weight
14	400x205x353	3 kg

Options and accessories

- Alarm
- Foot pedal
- Thermostatic mixing valve
- Stainless steel

Technical information

Model no.	Flow rate (l/min)	Water inlet (BSP)	Drain (BSP)	Width (mm)	Height (mm)	Depth (mm)	Weight (kg)
3863	14	1/2" female	1 1/4" female	400	195	353	3
3864	28	1/2" female	1 1/4" female	400	195	353	3
3866	28	1/2" female	1 1/4" female	400	205	353	3
3867	28+14	1/2" female	1 1/4" female	400	195	353	4,5
3868	14	1/2" female	1 1/4" female	400	205	353	3

Krusman Eye- and facewashes

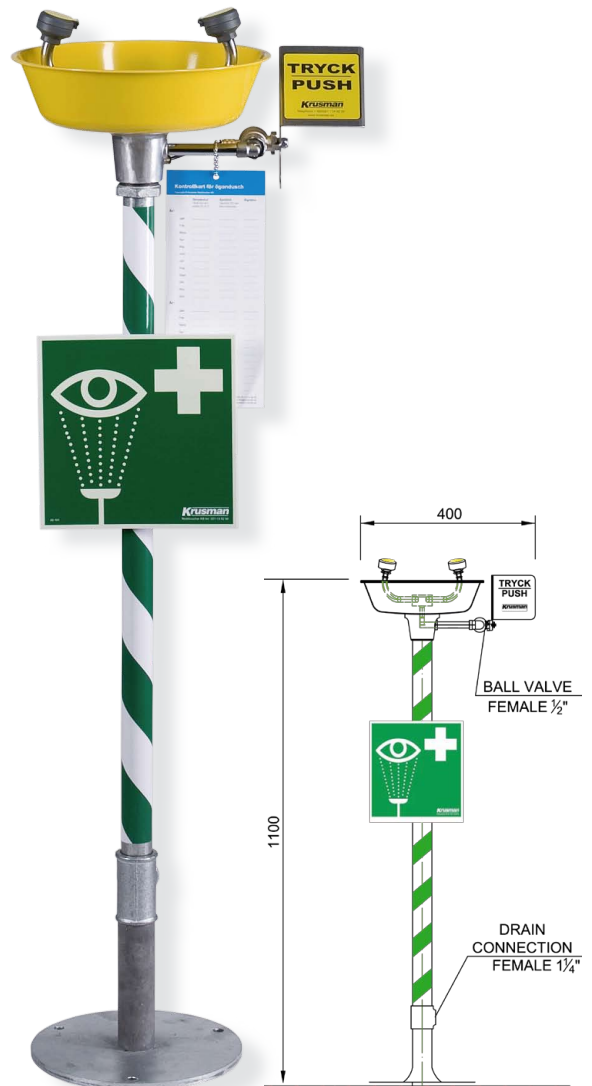
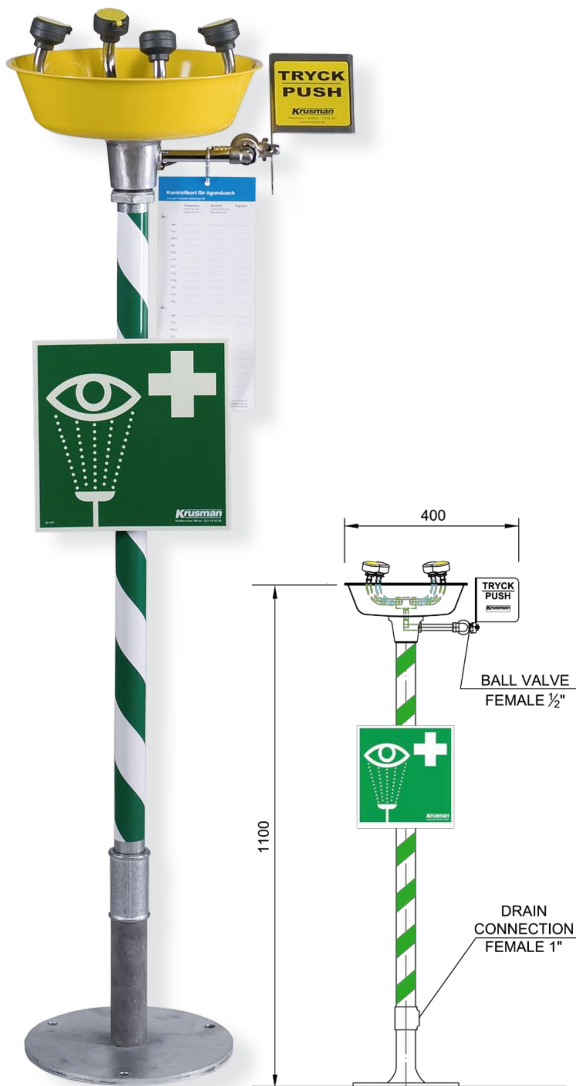

• Model 3869

Krusman eye- and facewash, floor model

Each individual spray head has built-in flow control and filter. Operated by a push plate, stay-open ball valve. The eye/facewash is self-draining. The placement of the spray head gives both eyes and face washing.

Complete with collecting bowl in powder-coated stainless steel, green/white stripe, galvanized steel pipes and other details in chrome-plated brass. Working pressure: 2.4-6.5 bar.

Pictogram eyewash sign is included with each eye/facewash.

Flow rate (l/min)	Dimensions in mm (WxHxD)	Weight
28	400x1100x280	12 kg

Options and accessories

- Alarm
- Foot pedal
- Thermostatic mixing valve
- Stainless steel

• Model 3870

Krusman eyewash, floor model

Each individual spray head has built-in flow control and filter. Operated by a push plate, stay-open ball valve. The eyewash is self-draining.

Complete with collecting bowl in powder-coated stainless steel, green/white stripe, galvanized steel pipes and other details in chrome-plated brass. Working pressure: 2.4-6.5 bar.

Pictogram eyewash sign is included with each eye/facewash.

Flow rate (l/min)	Dimensions in mm (WxHxD)	Weight
14	400x1100x280	12 kg

Options and accessories

- Alarm
- Foot pedal
- Thermostatic mixing valve
- Stainless steel

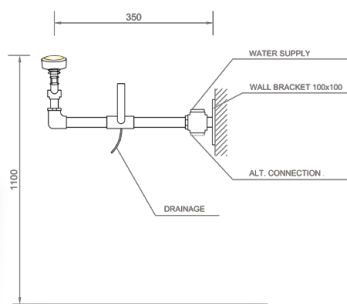

• Model 3830

Krusman eyewash, wall mounted

Each individual spray head has built-in flow control and filter. Operated by a push plate, stay-open ball valve. The eyewash is self-draining. Complete with galvanized steel and details in chrome-plated brass. Working pressure: 2.4-6.5 bar.

Pictogram eyewash sign is included with each eye/facewash.

Flow rate (l/min)	Dimensions in mm (WxHxD)	Weight
28	185x100x350	2 kg

Options and accessories

- Alarm
- Foot pedal
- Thermostatic mixing valve
- Stainless steel

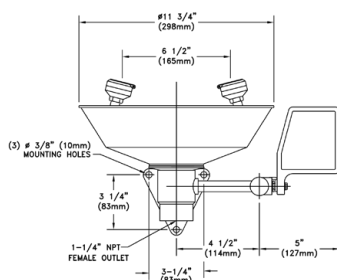

• Model 3884

Krusman eyewash plastic, wall mounted

Eyewash with collecting bowl and spray heads in ABS-plastic, other details in chrome-plated brass and wall bracket in painted aluminum. Each individual spray head has built-in flow control and filter. Operated by a push plate, stay-open ball valve. Working pressure: 2.4-6.5 bar.

Pictogram eyewash sign is included with each eye/facewash.

Flow rate (l/min)	Dimensions in mm (WxHxD)	Weight
14	400x178x292	3 kg

Options and accessories

- Alarm
- Thermostatic mixing valve

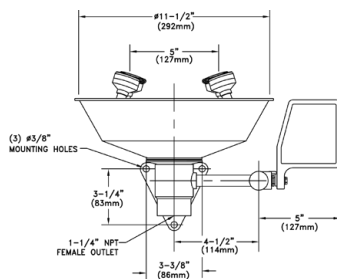

• Model KN1724P

Krusman eye- and facewash plastic, wall mounted

Eyewash with collecting bowl and spray heads in ABS-plastic, other details in chrome-plated brass and wall bracket in painted aluminum. Each individual spray head has built-in flow control and filter. Operated by a push plate, stay-open ball valve. The placement of the spray heads gives both eyes and face washing. Working pressure: 2.4-6.5 bar.

Pictogram eyewash sign is included with each eye/facewash.

Flow rate (l/min)	Dimensions in mm (WxHxD)	Weight
28	400x178x292	3 kg

Options and accessories

- Alarm
- Thermostatic mixing valve

Technical information

Model no.	Flow rate (l/min)	Water inlet (BSP)	Drain (BSP)	Width (mm)	Height (mm)	Depth (mm)	Weight (kg)
3869	28	1/2" female	1 1/4" female	400	1100	280	12
3870	14	1/2" female	1 1/4" female	400	1100	280	12
3830	28	1/2" female	-	185	100	350	2
3884	14	1/2" female	1 1/4" female	400	178	292	3
KN1724P	28	1/2" female	1 1/4" female	400	178	292	3

ООО «ТИ-СИСТЕМС» ИНЖИНИРИНГ И ПОСТАВКА ТЕХНОЛОГИЧЕСКОГО ОБОРУДОВАНИЯ
 Интернет: www.tisys.ru www.tisys.kz www.tisys.by www.tesec.ru www.ти-системс.рф
 Телефоны для связи: +7 (495) 7774788, 7489626, 5007154, 55, 65
 Эл. почта: info@tisys.ru info@tisys.kz info@tisys.by



• Model 99-200

Krusman portable eyeshower with wall rack

Portable eyeshower for indoor environments. For dirty environments we recommend enclosure cabinet 99-300. The shower liquid consists of isotonic 0.9% sodium chloride solution. The risk of growing Legionella and Pseudomonas bacteria in warm, stagnant water is eliminated.

Hit the red push button and the shower will start to flush both eyes and face for a minimum of 15 minutes. Both hands are free to keep the eyelids apart. Suitable distance between shower and eye is 25-30 cm.

To order a spare bottle specify model 99-000.

Flush time	Dimensions in mm (WxHxD)	Weight
15 min	195x330x140	2,5 kg

Pictogram eyewash sign is included with each eyewash.



• Model 99-300

Krusman cabinet for eyeshower

For environments with dust, dirt or splashing of chemical fluids. Recommended for example washing halls, butcher premises and cement works. Also appropriate where sterile removals are carried out. Shower bottle 99-000 is suitable for this cabinet. The cabinet is made of reinforced polyester and opens quickly with a handle. The shower can be triggered directly inside the rack or lifted out for use elsewhere.

- IP class 65
- The cabinet can be mounted on metal, wood or concrete wall with supplied screws.

Dimensions in mm (WxHxD)	Weight
445x485x240	6,7 kg

Pictogram eyewash sign is included with each cabinet.



• Model KN1540

Krusman portable eyewash 60L

Self-contained portable eyewash unit that uses gravity to deliver water through dual spray heads. Unit delivers over 53 litres of water for 15 minutes. The plastic tank can be installed in a wide variety of locations where potable water is not available.

It must be filled up with clean potable water and sterilising fluid must be added. Unit shall be inspected regularly and the water must be changed at least every sixth months.

To order a bottle of sterilising fluid specify KN1540BA.

Flush time	Dimensions in mm (WxHxD)	Weight
15 min	559x521x508	8 kg

Pictogram eyewash sign is included with each eyewash.



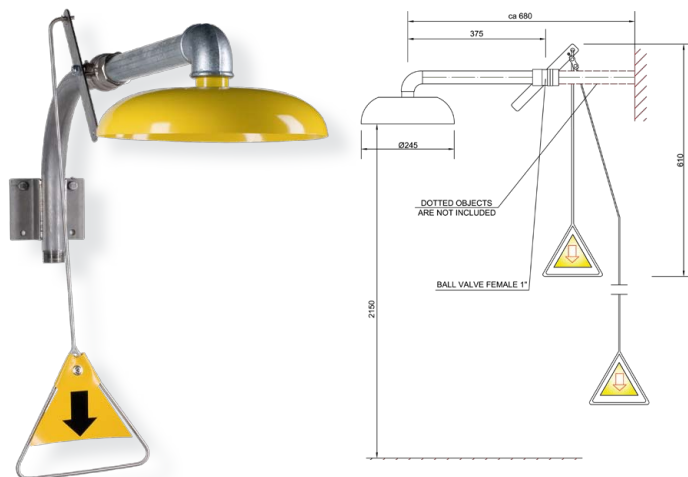

• Model 3813

Krusman emergency shower, wall mounted

Krusman emergency shower with galvanized steel pipes and shower head in powder-coated stainless steel. Stay-open ball valve, operated by a pull handle and a pull rod for crawling person. Working pressure: 2.4-6.5 bar.

The wall bracket (3887) is ordered separately.

Pictogram emergency shower sign is included with each shower.

Flow rate (l/min)	Dimensions in mm (WxHxD)	Weight
170	245x610x680	4 kg

Options and accessories

- Alarm
- Step-on foot grid or foot pedal
- Stainless steel
- Drench hose unit

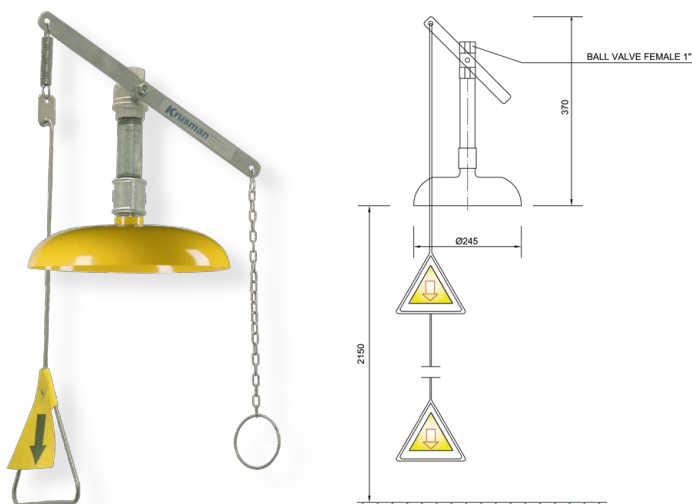

• Model 3814

Krusman emergency shower, suspended model

Suspended model with galvanized steel pipes and shower head in powder-coated stainless steel. Stay-open ball valve, operated by a pull handle and a pull rod for crawling person. Working pressure: 2.4-6.5 bar.

Pictogram emergency shower sign is included with each shower.

Flow rate (l/min)	Dimensions in mm (WxHxD)	Weight
170	245x610x245	4 kg

Options and accessories

- Alarm
- Stainless steel

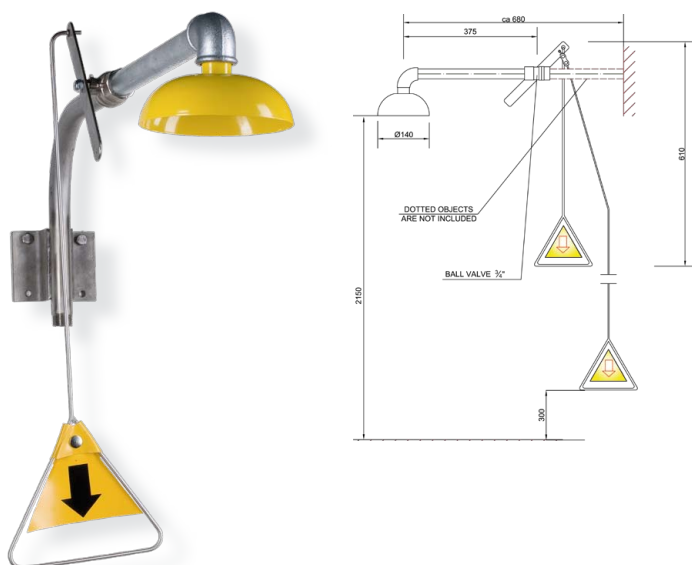

• Model 3836

Krusman emergency shower, wall mounted

Krusman emergency shower with galvanized steel pipes and shower head in powder-coated stainless steel. Stay-open ball valve, operated by a pull handle and a pull rod for crawling person. Working pressure: 2.4-6.5 bar.

The wall bracket (3886) is ordered separately.

Pictogram emergency shower sign is included with each shower.

Flow rate (l/min)	Dimensions in mm (WxHxD)	Weight
76	140x610x680	3 kg

Options and accessories

- Alarm
- Step-on foot grid or foot pedal
- Stainless steel

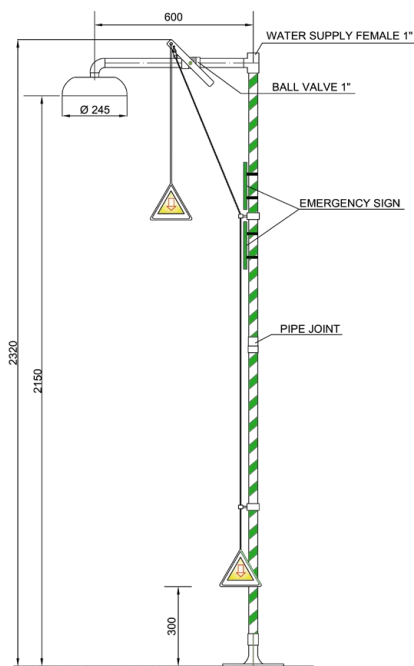

• Model 3811

Krusman emergency shower, free standing

Krusman emergency shower with galvanized steel pipes, green/white stripe and shower head in powder-coated stainless steel.

Stay-open ball valve, operated by a pull handle and a pull rod for crawling person.

Working pressure: 2.4-6.5 bar.

Pictogram emergency shower sign is included with each shower.

Flow rate (l/min)	Dimensions in mm (WxHxD)	Weight
170	245x2320x845	17 kg

Options and accessories

- Alarm
- Step-on foot grid or foot pedal
- Stainless steel
- Drench hose unit

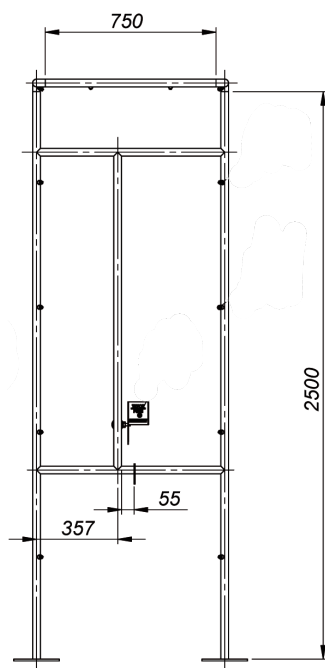
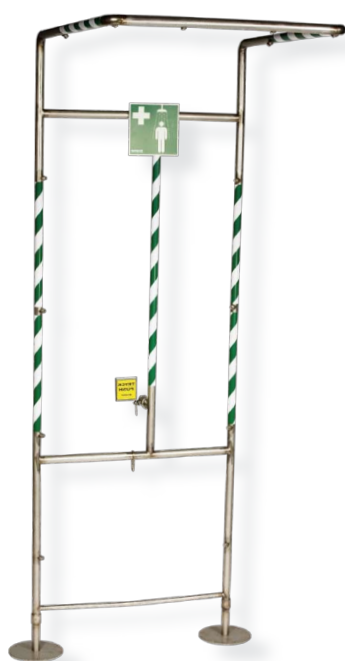

• Model 3823

Krusman decontamination shower, free standing

Krusman emergency shower in stainless steel, with green/white stripe and 14 nozzles in stainless steel.

Stainless steel stay-open ball valve, operated by a stainless steel push plate. Working pressure: 2.4-6.5 bar.

Pictogram emergency shower sign is included with each shower.

Flow rate (l/min)	Dimensions in mm (WxHxD)	Weight
195	1070x2556x1120	37 kg

Options and accessories

- Alarm
- Step-on foot grid
- Eyewash
- Drench hose unit

Technical information

Model no.	Flow rate (l/min)	Water inlet (BSP)	Drain	Width (mm)	Height (mm)	Depth (mm)	Weight (kg)
3813	170	1" female	-	245	610	680	4
3814	170	1" female	-	245	610	245	4
3836	76	3/4" female	-	140	610	680	3
3811	170	1" female	-	245	2320	845	17
3823	195	1" female	-	1070	2556	1120	37

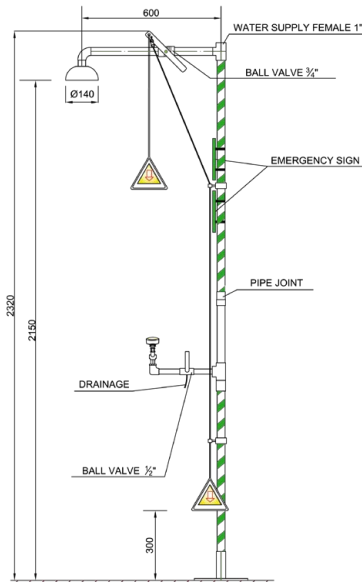

• Model 3872

Krusman safety station, free standing

Krusman safety station with galvanized steel pipes, green/white stripe and shower head in powder-coated stainless steel. Stay-open ball valve, operated by a pull handle and a pull rod for crawling person. Working pressure: 2.4-6.5 bar.

Eyewash 3830, each individual spray head has built-in flow control and filter. The eyewash is self-draining.

Pictogram emergency shower sign is included with each shower.

Flow rate (l/min)	Dimensions in mm (WxHxD)	Weight
76 / 28	400x2320x790	20 kg

Options and accessories

- Alarm
- Foot pedal or step-on foot grid
- Stainless steel
- Drench hose unit

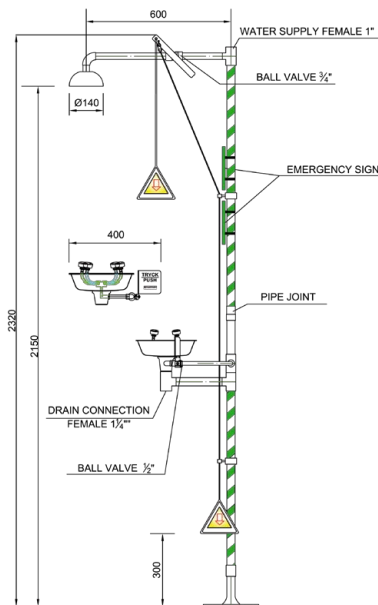

• Model 3873

Krusman safety station, free standing

Krusman safety station with galvanized steel pipes, green/white stripe and shower head in powder-coated stainless steel. Stay-open ball valve, operated by a pull handle and a pull rod for crawling person. Working pressure: 2.4-6.5 bar.

Eyewash 3864, each individual spray head has built-in flow control and filter. The eye/facewash is self-draining.

Pictogram emergency shower sign is included with each shower.

Flow rate (l/min)	Dimensions in mm (WxHxD)	Weight
76 / 28	400x2320x790	20 kg

Options and accessories

- Alarm
- Foot pedal or step-on foot grid
- Stainless steel
- Drench hose unit

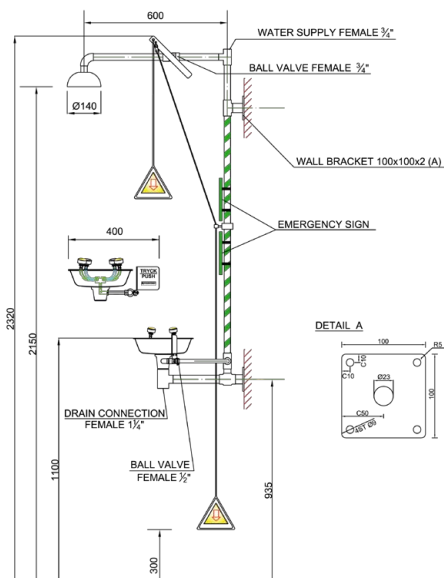

• Model 3874

Krusman safety station, wall mounted

Krusman safety station with galvanized steel pipes, green/white stripe and shower head in powder-coated stainless steel. Stay-open ball valve, operated by a pull handle and a pull rod for crawling person. Working pressure: 2.4-6.5 bar.

Eyewash 3864, each individual spray head has built-in flow control and filter. The eye/facewash is self-draining.

Pictogram emergency shower sign is included with each shower.

Flow rate (l/min)	Dimensions in mm (WxHxD)	Weight
76 / 28	400x1415x725	15 kg

Options and accessories

- Alarm
- Foot pedal or step-on foot grid
- Stainless steel
- Drench hose unit

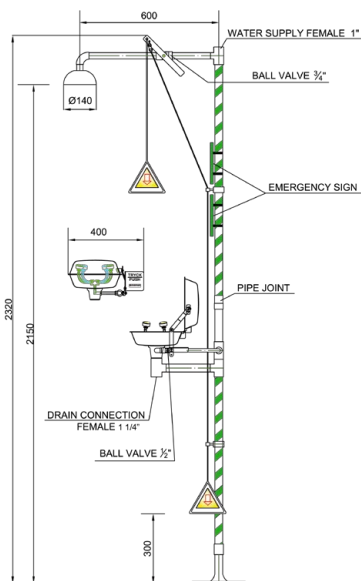

• Model 3888

Krusman safety station, free standing

Krusman safety station with galvanized steel pipes, green/white stripe and shower head in powder-coated stainless steel. Stay-open ball valve, operated by a pull handle and a pull rod for crawling person. Working pressure: 2.4-6.5 bar.

Eyewash 3866, each individual spray head has built-in flow control and filter. The eye/facewash is self-draining.

Pictogram emergency shower sign is included with each shower.

Flow rate (l/min)	Dimensions in mm (WxHxD)	Weight
76 / 28	400x2320x790	20 kg

Options and accessories

- Alarm
- Foot pedal or step-on foot grid
- Stainless steel
- Drench hose unit

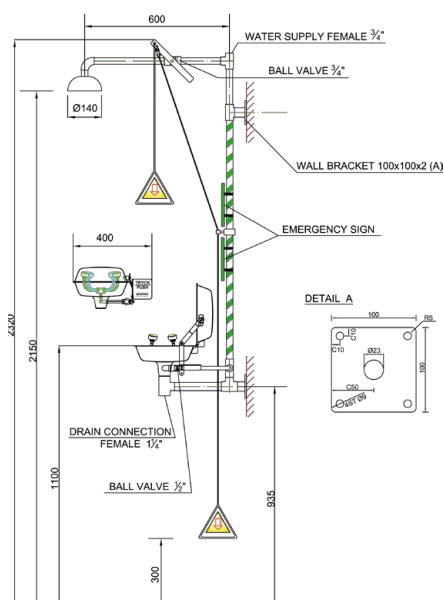

• Model 3889

Krusman safety station, wall mounted

Krusman safety station with galvanized steel pipes, green/white stripe and shower head in powder-coated stainless steel. Stay-open ball valve, operated by a pull handle and a pull rod for crawling person. Working pressure: 2.4-6.5 bar.

Eyewash 3866, each individual spray head has built-in flow control and filter. The eye/facewash is self-draining.

Pictogram emergency shower sign is included with each shower.

Flow rate (l/min)	Dimensions in mm (WxHxD)	Weight
76 / 28	400x1415x725	15 kg

Options and accessories

- Alarm
- Foot pedal or step-on foot grid
- Stainless steel
- Drench hose unit

Technical information

Model no.	Flow rate body/eyes (l/min)	Water inlet (BSP)	Drain (BSP)	Width (mm)	Height (mm)	Depth (mm)	Weight (kg)
3872	76 / 28	1" female	-	400	2320	790	20
3873	76 / 28	1" female	1 1/4" female	400	2320	790	20
3874	76 / 28	3/4" female	1 1/4" female	400	1415	725	15
3888	76 / 28	1" female	1 1/4" female	400	2320	790	20
3889	76 / 28	3/4" female	1 1/4" female	400	1415	725	15

Krusman Safety stations with mixing valves

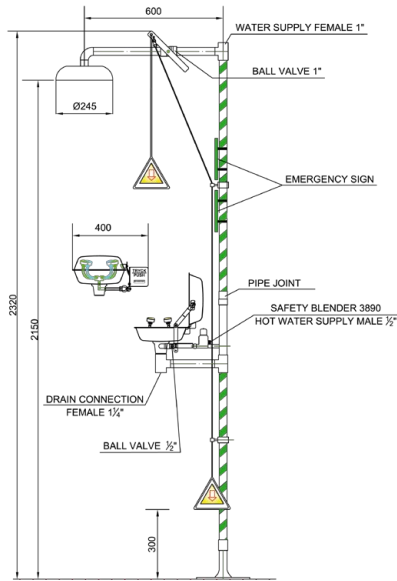

• Model 3875

Krusman safety station, tempering on eyewash

Krusman free standing safety station with tempering on eyewash, galvanized steel pipes, green/white stripe and shower head in powder-coated stainless steel. Stay-open ball valve, operated by a pull handle and a pull rod for crawling person. Working pressure: 2.4-6.5 bar. Eyewash 3866, each individual spray head has built-in flow control and filter. The eye/facewash is self-draining.

Pictogram emergency shower sign is included with each shower.

Flow rate (l/min)	Dimensions in mm (WxHxD)	Weight
170 / 28	400x2320x845	20 kg

Options and accessories

- Alarm
- Foot pedal or step-on foot grid
- Stainless steel
- Drench hose unit

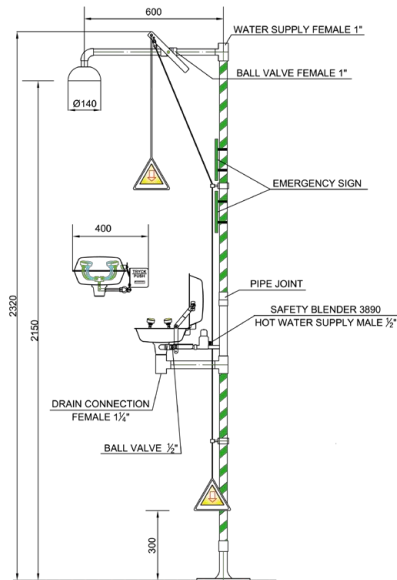

• Model 3876

Krusman safety station, tempering on eyewash

Krusman free standing safety station with tempering on eyewash, galvanized steel pipes, green/white stripe and shower head in powder-coated stainless steel. Stay-open ball valve, operated by a pull handle and a pull rod for crawling person. Working pressure: 2.4-6.5 bar. Eyewash 3866, each individual spray head has built-in flow control and filter. The eye/facewash is self-draining.

Pictogram emergency shower sign is included with each shower.

Flow rate (l/min)	Dimensions in mm (WxHxD)	Weight
76 / 28	400x2320x790	20 kg

Options and accessories

- Alarm
- Foot pedal or step-on foot grid
- Stainless steel
- Drench hose unit

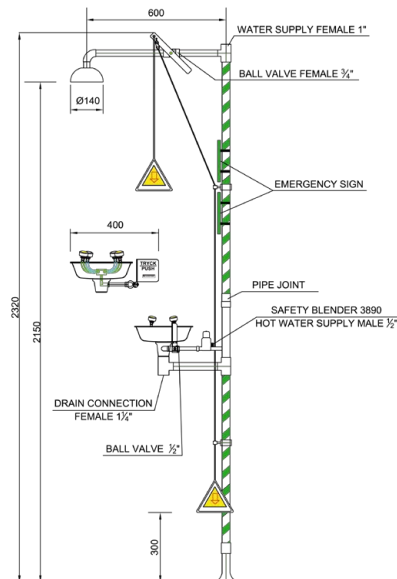

• Model 3877

Krusman safety station, tempering on eyewash

Krusman free standing safety station with tempering on eyewash, galvanized steel pipes, green/white stripe and shower head in powder-coated stainless steel. Stay-open ball valve, operated by a pull handle and a pull rod for crawling person. Working pressure: 2.4-6.5 bar. Eyewash 3864, each individual spray head has built-in flow control and filter. The eye/facewash is self-draining.

Pictogram emergency shower sign is included with each shower.

Flow rate (l/min)	Dimensions in mm (WxHxD)	Weight
76 / 28	400x2320x790	20 kg

Options and accessories

- Alarm
- Foot pedal or step-on foot grid
- Stainless steel
- Drench hose unit

ООО «ТИ-СИСТЕМС» ИНЖИНИРИНГ И ПОСТАВКА ТЕХНОЛОГИЧЕСКОГО ОБОРУДОВАНИЯ

Интернет: www.tisys.ru www.tisys.kz www.tisys.by www.tesec.ru www.ти-системс.рф

Телефоны для связи: +7 (495) 7774788, 7489626, 5007154, 55, 65

Эл. почта: info@tisys.ru info@tisys.kz info@tisys.by

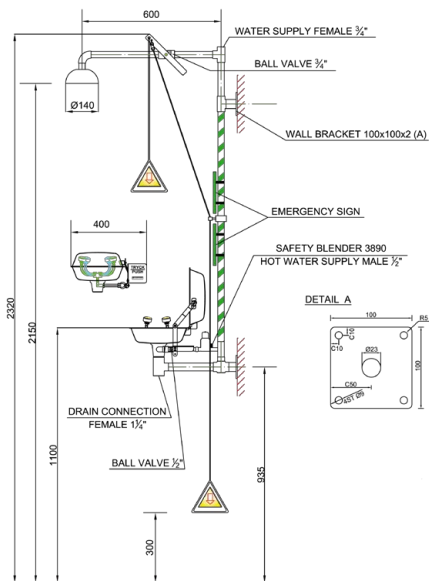

• Model 3878

Krusman safety station, tempering on eyewash

Krusman wall mounted safety station with tempering on eyewash, galvanized steel pipes, green/white stripe and shower head in powder-coated stainless steel. Stay-open ball valve, operated by a pull handle and a pull rod for crawling person. Working pressure: 2.4-6.5 bar. Eyewash 3866, each individual spray head has built-in flow control and filter. The eye/facewash is self-draining.

Pictogram emergency shower sign is included with each shower.

Flow rate (l/min)	Dimensions in mm (WxHxD)	Weight
76 / 28	400x1415x725	15 kg

Options and accessories

- Alarm
- Foot pedal or step-on foot grid
- Stainless steel
- Drench hose unit

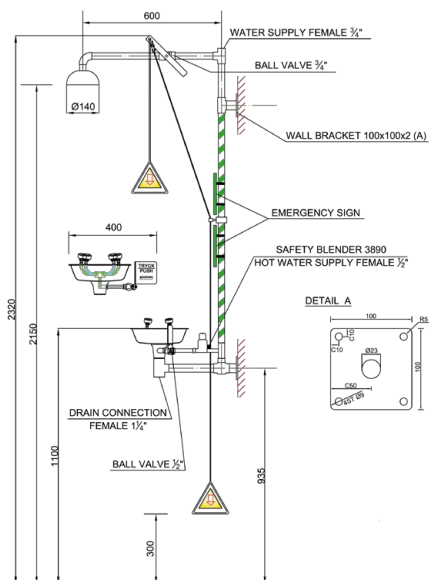

• Model 3879

Krusman safety station, tempering on eyewash

Krusman wall mounted safety station with tempering on eyewash, galvanized steel pipes, green/white stripe and shower head in powder-coated stainless steel. Stay-open ball valve, operated by a pull handle and a pull rod for crawling person. Working pressure: 2.4-6.5 bar. Eyewash 3864, each individual spray head has built-in flow control and filter. The eye/facewash is self-draining.

Pictogram emergency shower sign is included with each shower.

Flow rate (l/min)	Dimensions in mm (WxHxD)	Weight
76 / 28	400x1415x725	15 kg

Options and accessories

- Alarm
- Foot pedal or step-on foot grid
- Stainless steel
- Drench hose unit

Technical information

Model no.	Flow rate body/eyes (l/min)	Water inlet cold (BSP)	Water inlet hot (BSP)	Drain (BSP)	Width (mm)	Height (mm)	Depth (mm)	Weight (kg)
3875	170 / 28	1" female	1/2" male	1 1/4" female	400	2320	845	20
3876	76 / 28	1" female	1/2" male	1 1/4" female	400	2320	790	20
3877	76 / 28	1" female	1/2" male	1 1/4" female	400	2320	790	20
3878	76 / 28	3/4" female	1/2" male	1 1/4" female	400	1415	725	15
3879	76 / 28	3/4" female	1/2" male	1 1/4" female	400	1415	725	15

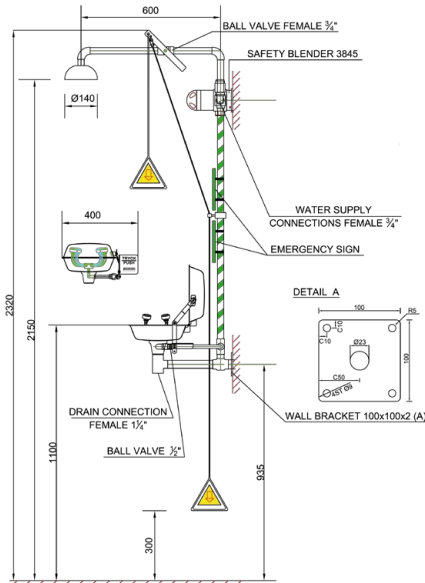

• Model 3880

Krusman safety station, tempering on body/eye

Krusman wall mounted safety station with tempering, galvanized steel pipes, green/white stripe and shower head in powder-coated stainless steel. Stay-open ball valve, operated by a pull handle and a pull rod for crawling person. Working pressure: 2.4-6.5 bar. Eyewash 3866, each individual spray head has built-in flow control and filter. The eye/facewash is self-draining.

Pictogram emergency shower sign is included with each shower.

Flow rate (l/min)	Dimensions in mm (WxHxD)	Weight
76 / 28	400x1415x725	15 kg

Options and accessories

- Alarm
- Foot pedal or step-on foot grid
- Stainless steel
- Drench hose unit

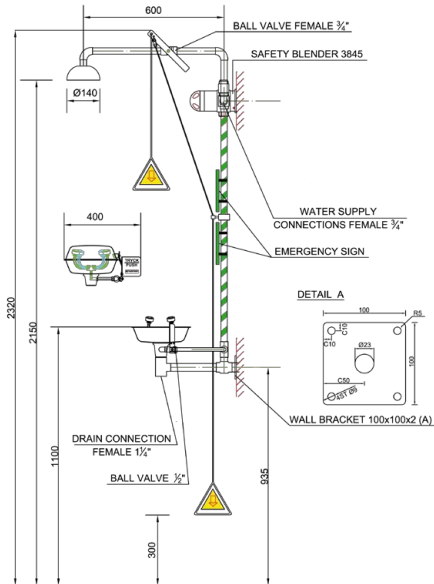

• Model 3881

Krusman safety station, tempering on body/eye

Krusman wall mounted safety station with tempering, galvanized steel pipes, green/white stripe and shower head in powder-coated stainless steel. Stay-open ball valve, operated by a pull handle and a pull rod for crawling person. Working pressure: 2.4-6.5 bar. Eyewash 3864, each individual spray head has built-in flow control and filter. The eye/facewash is self-draining.

Pictogram emergency shower sign is included with each shower.

Flow rate (l/min)	Dimensions in mm (WxHxD)	Weight
76 / 28	400x1415x725	15 kg

Options and accessories

- Alarm
- Foot pedal or step-on foot grid
- Stainless steel
- Drench hose unit

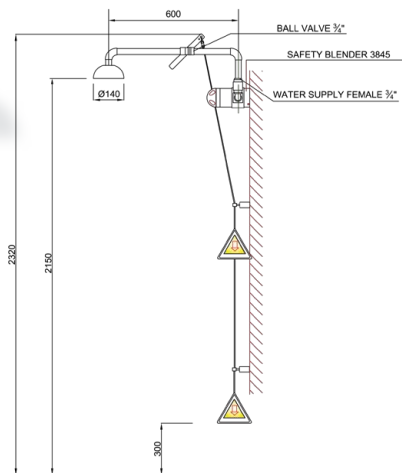

• Model 3846

Krusman emergency shower with tempering

Krusman wall mounted emergency shower with tempering, galvanized steel pipes and shower head in powder-coated stainless steel. Stay-open ball valve, operated by pull handle and a pull rod for crawling person. Working pressure: 2.4-6.5 bar. Mounting height above floor approximately 2150 mm.

Pictogram emergency shower sign is included with each shower.

Flow rate (l/min)	Dimensions in mm (WxHxD)	Weight
76	200x610x725	9 kg

Options and accessories

- Alarm
- Foot pedal or step-on foot grid
- Stainless steel
- Drench hose unit

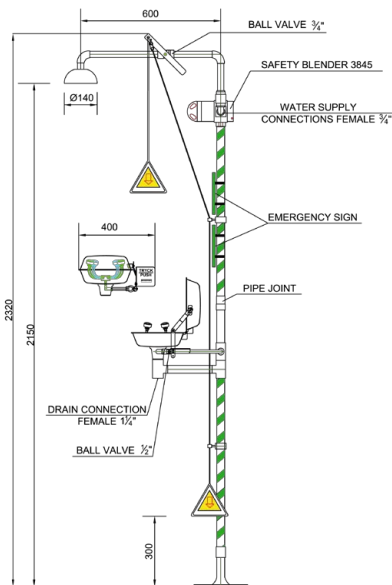

• Model 3882

Krusman safety station, tempering on body/eye

Krusman free standing safety station with tempering, galvanized steel pipes, green/white stripe and shower head in powder-coated stainless steel. Stay-open ball valve, operated by a pull handle and a pull rod for crawling person. Working pressure: 2.4-6.5 bar. Eyewash model 3866, each individual spray head has built-in flow control and filter. The eye/facewash is self-draining.

Pictogram emergency shower sign is included with each shower.

Flow rate (l/min)	Dimensions in mm (WxHxD)	Weight
76 / 28	400x2320x790	20 kg

Options and accessories

- Alarm
- Foot pedal or step-on foot grid
- Stainless steel
- Drench hose unit

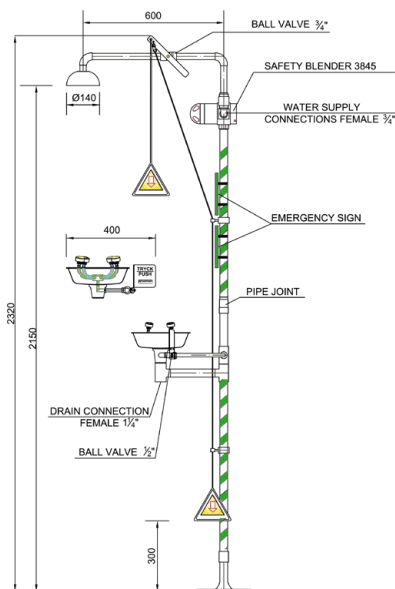

• Model 3883

Krusman safety station, tempering on body/eye

Krusman free standing safety station with tempering, galvanized steel pipes, green/white stripe and shower head in powder-coated stainless steel. Stay-open ball valve, operated by a pull handle and a pull rod for crawling person. Working pressure: 2.4-6.5 bar. Eyewash model 3864, each individual spray head has built-in flow control and filter. The eye/facewash is self-draining.

Pictogram emergency shower sign is included with each shower.

Flow rate (l/min)	Dimensions in mm (WxHxD)	Weight
76 / 28	400x2320x790	20 kg

Options and accessories

- Alarm
- Foot pedal or step-on foot grid
- Stainless steel
- Drench hose unit

Technical information

Model no.	Flow rate body/eyes (l/min)	Water inlet cold (BSP)	Water inlet hot (BSP)	Drain (BSP)	Width (mm)	Height (mm)	Depth (mm)	Weight (kg)
3880	76 / 28	3/4" female	3/4" female	1 1/4" female	400	1415	725	15
3881	76 / 28	3/4" female	3/4" female	1 1/4" female	400	1415	725	15
3846	76	3/4" female	3/4" female	-	200	610	725	9
3882	76 / 28	3/4" female	3/4" female	1 1/4" female	400	2320	790	20
3883	76 / 28	3/4" female	3/4" female	1 1/4" female	400	2320	790	20

Self-draining emergency shower with eye- and facewash.

• Model 8010 / 8020

Krusman self-draining emergency shower and eyewash system for outdoor/indoor use

Free standing safety station delivered with galvanized steel pipes, green/white stripe, spray heads made of ABS-plastic and shower head in powder-coated stainless steel. Stay-open ball valve, operated by a pull handle and a pull rod for crawling person.

Eyewash 3863/facewash 3864, each individual spray head has built-in flow control and filter.

The product is extra suitable for warm climates.

The self-draining safety station prevents hot stagnant water inside the shower. The flow rate of the body shower is 76 l/min, the flow rate of the eyewash 14 l/min and the flow rate of the eye/facewash is 28 l/min.

The flow rates are guaranteed only when the pressure in the main pipeline is approximately 2.4-6.5 bar. The water connection area should be modified according to existing climate conditions.

Pictogram emergency shower sign is included with each shower.

Flow rate (l/min)	Dimensions in mm (WxHxD)	Weight
76 / 14, 28	400x2320x790	20 kg

Options and accessories

- Alarm
- Foot pedal or step-on foot grid
- Eye- and facewash dustcover
- Flange connection
- Stainless steel

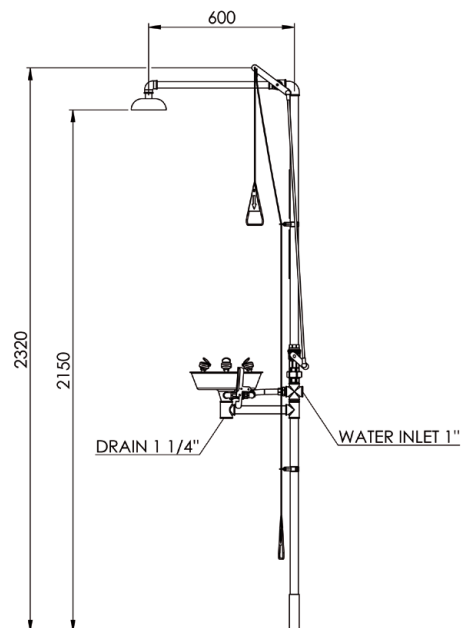

• Model 3819

Krusman safety station, freeze-resistant

Krusman insulated safety station for outside use with galvanized steel pipes, green/white stripe and shower head in powder-coated stainless steel. Stay-open ball valve, operated by a pull handle or a pull rod for crawling person. Eyewash 3830, each individual spray head has built-in flow control and filter. The eye/facewash is self-draining.

Manufactured for Ex-classified environments. Model available as free standing or wall mounted.

Technical data: The shower is constructed for outdoor installation. It is insulated and heat traced in order to prevent freezing. The shower material is approved for installation in hazard environments.

Water pressure: Automatic function for pressure between 2.4-6.5 bar with built-in flow controls and filters. If the water pressure exceeds 6.5 bar a pressure reducing valve must be installed.

Material: Shower head, valves and pull handle are manufactured in stainless steel. Galvanized steel pipes and fittings. The spray heads are manufactured in ABS-plastic.

Trace heated: Raychem CHEMELEX 3BTV2-CT self-regulating, 5 m (10W/m). Junction box with thermostat RAYSTAT-EX-03: Exe approved for explosion classified environments.

Insulation: Water based foam insulation from United Foam Ltd, Denmark.

Surface: Black PEH plastic pipes manufactured by Akatherm. Meet DIN and ISO standards.

Pictogram emergency shower sign is included with each shower.

Flow rate (l/min)	Dimensions in mm (WxHxD)	Weight
170 / 28	350x2320x900	100 kg

Options and accessories

- Alarm
- Foot pedal or step-on foot grid
- Flange connection
- Stainless steel pipes
- Drench hose unit

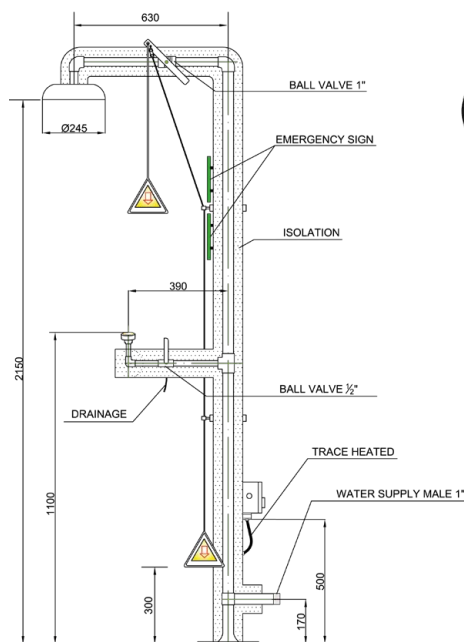

Technical information

Model no.	Flow rate body/eyes (l/min)	Water inlet (BSP)	Drain (BSP)	Width (mm)	Height (mm)	Depth (mm)	Weight (kg)
8010	76 / 14	1" female	1 1/4" female	400	2320	790	20
8020	76 / 28	1" female	1 1/4" female	400	2320	790	20
3819	170 / 28	1" male	-	350	2320	900	100



• Model 6010 / 6020

Krusman emergency shower booth

Model 6010: Insulated cabinet with safety station. Walls, ceiling and floor are made of 50 mm insulated sandwich elements with a surface of coated steel plates. Self closing pending doors. Inside, the floor has a vinyl carpet and drainage. The lightning and radiator are suitable for sanitary areas. U- value: 0,7W/m²K

Model 6020: Insulated cabinet with safety station and heater. Walls, ceiling and floor are made of 50 mm insulated sandwich elements with a surface of coated steel plates. Self closing pending doors. Inside, the floor has a vinyl carpet and drainage. The lightning and radiator are suitable for sanitary areas. U- value: 0,7W/m²K

Models are available for Ex-classified environments.

Pictogram emergency shower sign is included with each booth.



• Model 7010

Krusman tank shower system 800L with chiller unit

Emergency tank shower system 7010 incorporated with a pre-insulated 800 litre tank. The tank guarantees a flow of tempered water for up to 9 minutes (without new incoming water).

The emergency shower is fitted with a cooler/compressor to prevent extreme water temperatures in hot climates. A circulation pump allows the water to flow into the cooler aggregate and verifies the incoming water temperature. If the temperature is too high, the water will be chilled, according to the desired pre-programmed temperature.

The tank shower is supported on a stainless steel frame and fitted with phosphorescent pictogram signs.

Options and accessories

- Alarm
- Step-on foot grid



• Model 7020 / 7021 / 7022

Tank Shower 800L / 1200L / 2000L

Tank shower with insulated tank and frame made of massive stainless steel square-tubes. The stainless steel tank is corrosion resistant. The 1200L tank guarantees a flush time of 30 minutes. Insulation is made of polyurethan. It is fitted with phosphorescent pictogram signs and green/white stripes for the visibility of the tank shower. Available with explosion-proof construction for EX-Zone 1 & 2. Shower arm, ball valve 1" and push plate/arm made of stainless steel. Shower head made of chemical resistant plastics, corrosion resistant, and self-draining.

For flow rates and dimensions see technical information below.

Options and accessories

- Alarm
- Back/side panels
- Step-on foot grid
- Level indicator
- Temperature indicator
- Heater

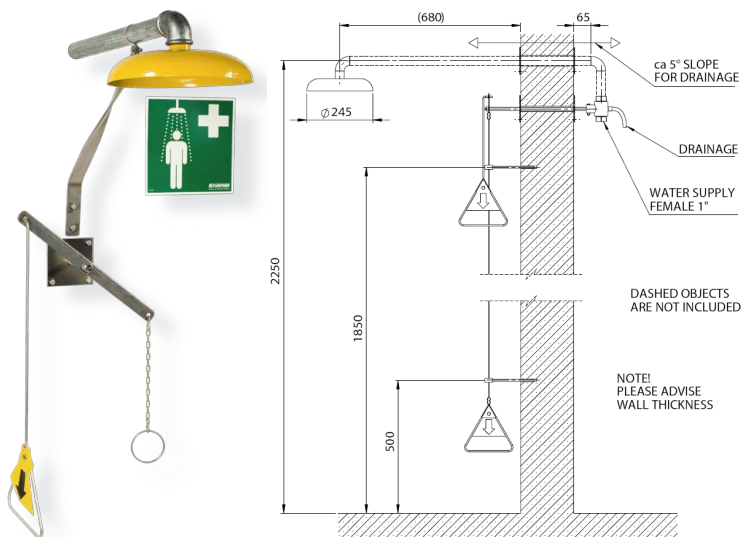

• Model 3826

Krusman emergency shower for outdoor use, wall mounted

Emergency shower with shower head in powder-coated stainless steel. Stay-open ball valve, operated by a pull handle and a pull rod for crawling person. Working pressure: 2.4-6.5 bar.

Please advise wall thickness when placing order.
Pictogram emergency shower sign is included with each shower.

Flow rate (l/min) 170 **Weight** 5 kg

Options and accessories

- Alarm
- Step-on foot grid or foot pedal
- Stainless steel

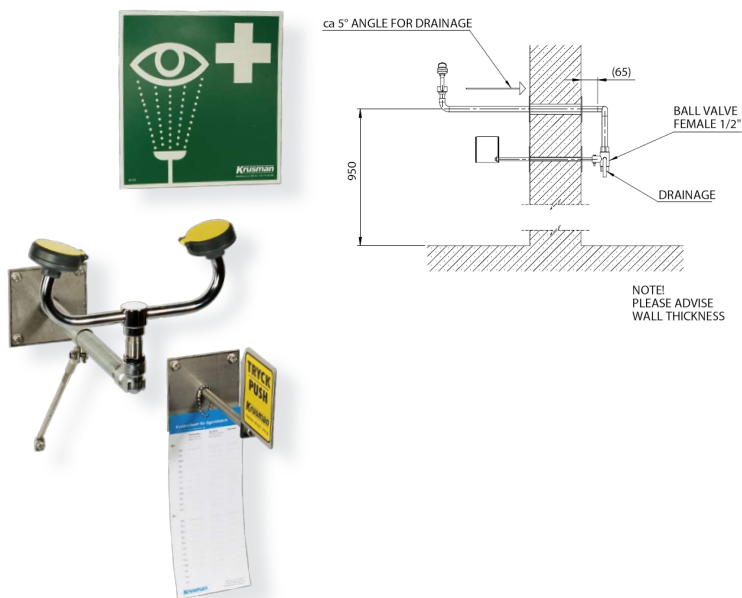

• Model 3871

Krusman eyewash for outdoor use, wall mounted

Eyewash for outdoor use, each individual spray head has built-in flow control and filter. Stay-open ball valve, operated by a push plate. The eyewash is self-draining. Working pressure: 2.4-6.5 bar.

Please advise wall thickness when placing order.
Pictogram eyewash sign is included with each eye- and facewash.

Flow rate (l/min) 28 **Weight** 4 kg

Options and accessories

- Alarm
- Stainless steel
- Step-on-foot grid or foot pedal

Technical information

Model no.	Flow rate body/eyes (l/min)	Water inlet (BSP)	Drain	Width (mm)	Height (mm)	Depth (mm)	Weight (kg)
6010	Dep. on model	1" male	75 mm	1218	2600	1330	400
6020	Dep. on model	1" male	75 mm	1324	2600	2300	900
7010	76 / 14	1" flange	-	2042	3833	1942	1000
7020	40	1 1/4" female	-	1410	3255	1290	400
7021	40	1 1/4" female	-	1430	3545	1310	400
7022	40	1 1/4" female	-	1800	3545	1660	400
3826	170	1" female	-	-	-	-	5
3871	28	1/2" female	-	-	-	-	4



• Model IG 5533

Proximity switch

- IG-2008-FRKG
- Plastic thread M18 x 1
- Connection PUR/ PVC- cable
- Programmable

Visit www.krusman.com for more detailed technical information.



• Model KND605

Safety switch

- Safety switch EEx 95 TL
- Explosion-proof, zone 1 and 2
- Material: Thermoplastic enclosure
- Overlapping contacts and one NO and one NC contact.
- Actuator head can be repositioned in steps 4 x 90°

Visit www.krusman.com for more detailed technical information.



• Model XCK-M106

Limit switch

Osiswitch limit switch with plunger head.

- Metal
- Three cable entries
- Contact:
- 2-pole 1 N/C + 1 N/O
- Connection:
- Cable entry 3x PG11

Visit www.krusman.com for more detailed technical information.



• Model SP-G 15/20

Flow control switch for eye/face washes

The SP-G and EF-G models are designed for smaller pipe dimensions with threaded process connections of 1/2" and 3/4". The maximum flow capacity is 70 l/min and they are equipped with one fixed set-point.

This set-point can be modified on site by simply replacing a calibrated disc and also the connections can be adapted to other dimensions by using nipples and reductions. The SP-G model has a mechanical micro switch and the EF-G has an inductive proximity switch.

Visit www.krusman.com for more detailed technical information.



• Model SP-GA 25/32/40

Flow control switch for safety stations

SP-GA is a larger model with a 1 1/2" process connection and one mechanical micro switch. It also has a field-adjustable set-point within a range of 3-70 l/min whilst allowing a maximum flow rate of 300 l/min.

Filters and reducer couplings are available to adapt it to smaller pipes as low as 1".

Visit www.krusman.com for more detailed technical information.



• Model dSLB 20

Ex II Strobe light

Robust optical signalling device for use in areas with explosive atmospheres in group II and zones 1 and 21.

- Compact construction
- Versatile
- Light intensity up to 15 joule
- Protection degree IP 66 / 67
- Explosion protection class
- II 2G Ex de IIC T6
- II 2 D Ex tD A21 IP66 / IP67 T80°C

Visit www.krusman.com for more detailed technical information.





KND532



KND533



KND534



KND540



KND501



3886



3887

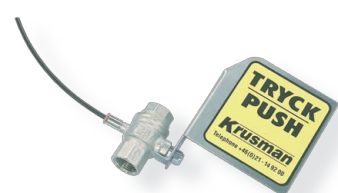

KND515



KND520



KND525



KND555



KND556

Options and accessories

Article no.	Description	Material
KND532	Pull rod inclusive flag	Stainless steel
KND533	Flag	Plastic
KND534	Handle for KND540 inclusive flag.	Stainless steel
KND540-10.1	Pull handle for wall mounting.	Non-corrosive wire
KND540-10.4	Pull handle for wall mounting.	Wire in stainless steel
KND540-20.1	Pull handle for mounting on pipe 3/4\".	Non-corrosive wire
KND540-20.4	Pull handle for mounting on pipe 3/4\".	Wire in stainless steel
KND540-25.1	Pull handle for mounting on pipe 1\".	Non-corrosive wire
KND540-25.4	Pull handle for mounting on pipe 1\".	Wire in stainless steel
KND540-32.1	Pull handle for mounting on pipe 1 1/4\".	Non-corrosive wire
KND540-32.4	Pull handle for mounting on pipe 1 1/4\".	Wire in stainless steel
KND501	Wall bracket to eye- and facewashes.	Aluminium
3886	Wall bracket for emergency shower 3836, 3/4\".	Galvanized steel
3887	Wall bracket for emergency shower 3813, 1\".	Galvanized steel
KND515	Ball valve with push plate, for eye- and facewash, 1/2\".	Chrome-plated brass
KND515-00	Ball valve with push plate, for eye- and facewash, 1/2\".	Stainless steel
KND520	Ball valve with arm 3/4\", for emergency shower.	Chrome-plated brass
KND520-00	Ball valve with arm 3/4\", for emergency shower.	Stainless steel
KND525	Ball valve with arm 1\", for emergency shower.	Chrome-plated brass
KND525-00	Ball valve with arm 1\", for emergency shower.	Stainless steel
KND555	Non-returing valve 3/4\", for thermostatic mixing valve 3845.	Chrome-plated brass
KND556	Non-returing valve 1\", for thermostatic mixing valve 3843.	Chrome-plated brass



KND506 / KND508



KND505 / KND507



KND510



KND511



KND530 / KND531



KND559



KND545



KND547



KND548



KND570



KND575

Options and accessories

Article no.	Description	Material
KND506	Filter for small spray head KND505.	Polyurethane filter
KND508	Filter for large spray head KND507.	Polyurethane filter
KND505	Small spray head, 7 l/m with integrated nylon dust cover (fits KND510 / KND511).	ABS-plastic
KND507	Large spray head, 14 l/m with integrated nylon dust cover (fits KND510).	ABS-plastic
KND510	Eyewash assembly, 14 l/min (7 l/min per spray head).	ABS-plastic/Chrome-plated brass
KND511	Eye- and facewash assembly, 28 l/min (7 l/min per spray head).	ABS-plastic/Chrome-plated brass
KND530	Shower head in powder-coated stainless steel, ø 245 mm, 170 l/min.	Stainless steel
KND531	Shower head in powder-coated stainless steel, ø 140 mm, 76 l/min.	Stainless steel
KND559	Filter for eye- and facewash, pipe 1/2".	Chrome-plated brass (filter ss)
KND545	Pictogram sign for eyewash.	Green plastic
KND547	Pictogram sign for emergency shower.	Green plastic
KND548	Angle shaped plate for two signs (signs not included).	White plastic
KND570	Foot pedal for eye- and facewash, pipe 1". (Available as wall mounting/free standing)	Stainless steel
KND575	Step-on foot grid for activating emergency shower.	Galvanized steel

Krusman Packing for transport by BOAT

Model no.	WxDxH (cm)	Kg	Max pallet	Pallet dimensions (cm)	Pallet weight (kg)
KN1540	60x60x80	8	6	120x80x200	68
KN1724P	40x40x26	3	36	120x80x176	153
3811	120x40x55	17	6	120x80x185	122
3813	76x32x12	4	36	120x80x164	164
3814	76x32x12	4	36	120x80x164	164
3819	260x100x400	100	2	260x100x600	200
3823	260x100x10	37	5	1,3 volume	185
3826	60x20x15	5	66	120x80x185	350
3830	40x40x26	2	36	120x80x176	92
3836	76x32x12	3	36	120x80x164	128
3846	76x32x12	9	36	120x80x164	324
3863	40x40x26	3	36	120x80x176	153
3864	40x40x26	3	36	120x80x176	153
3866	40x40x26	3	36	120x80x176	153
3867	40x40x26	4,5	36	120x80x176	182
3868	40x40x26	3	36	120x80x176	153
3869	120x40x55	12	6	120x80x185	92
3870	120x45x55	12	6	120x80x185	92
3871	60x20x15	4	66	120x80x185	284
3872	120x40x55	20	6	120x80x185	140
3873	120x40x55	20	6	120x80x185	140
3874	120x40x55	15	6	120x80x185	110
3875	120x40x55	20	6	120x80x185	140
3876	120x40x55	20	6	120x80x185	140
3877	120x40x55	20	6	120x80x185	140
3878	120x40x55	15	6	120x80x185	110
3879	120x40x55	15	6	120x80x185	110
3880	120x40x55	15	6	120x80x185	110
3881	120x40x55	15	6	120x80x185	110
3882	120x40x55	20	6	120x80x185	140
3883	120x40x55	20	6	120x80x185	140
3884	40x40x26	3	36	120x80x176	153
3888	120x40x55	20	6	120x80x185	140
3889	120x40x55	15	6	120x80x185	110
6010	130x145x258	400	1	130x145x258	600
6020	240x145x262	900	1	240x145x262	1200
7010	230x132,4x260	1000	1	260x150x280	1200
7020	141x129x325	400	1	150x150x330	600
7021	143x131x354	400	1	150x150x360	600
7022	180x166x354	400	1	190x180x360	600
8010	120x40x55	20	6	120x80x185	140
8020	120x40x55	20	6	120x80x185	140
99-200	40x20x20	2,5	96	120x80x180	260
99-300	48x29x25	6,7	24	120x80x170	181

ООО «ТИ-СИСТЕМС» ИНЖИНИРИНГ И ПОСТАВКА ТЕХНОЛОГИЧЕСКОГО ОБОРУДОВАНИЯ

Интернет: www.tisys.ru www.tisys.kz www.tisys.by www.tesec.ru www.ти-системс.рф

Телефоны для связи: +7 (495) 7774788, 7489626, 5007154, 55, 65

Эл. почта: info@tisys.ru info@tisys.kz info@tisys.by

Krusman Packing for transport by AIR

Model no.	WxDxH (cm)	Kg	Max pallet	Pallet dimensions (cm)	Pallet weight (kg)
KN1540	60x60x80	8	4	120x80x150	52
KN1724P	40x40x26	3	30	120x80x150	110
3811	120x40x55	17	4	120x80x130	88
3813	76x32x12	4	10	120x80x140	60
3814	76x32x12	4	10	120x80x140	60
3819	-	-	-	-	-
3823	260x100x10	37	1	1,3 volume	37
3826	60x20x15	5	48	120x80x140	260
3830	40x40x26	2	30	120x80x150	80
3836	76x32x12	3	10	120x80x140	50
3846	76x32x12	9	10	120x80x140	110
3863	40x40x26	3	30	120x80x150	110
3864	40x40x26	3	30	120x80x150	110
3866	40x40x26	3	30	120x80x150	110
3867	40x40x26	4,5	30	120x80x150	155
3868	40x40x26	3	30	120x80x150	110
3869	120x40x55	12	4	120x80x130	68
3870	120x45x55	12	4	120x80x130	68
3871	60x20x15	4	48	120x80x140	212
3872	120x40x55	20	4	120x80x130	100
3873	120x40x55	20	4	120x80x130	100
3874	120x40x55	15	4	120x80x130	80
3875	120x40x55	20	4	120x80x130	100
3876	120x40x55	20	4	120x80x130	100
3877	120x40x55	20	4	120x80x130	100
3878	120x40x55	15	4	120x80x130	80
3879	120x40x55	15	4	120x80x130	80
3880	120x40x55	15	4	120x80x130	80
3881	120x40x55	15	4	120x80x130	80
3882	120x40x55	20	4	120x80x130	100
3883	120x40x55	20	4	120x80x130	100
3884	40x40x26	3	30	120x80x150	110
3888	120x40x55	20	4	120x80x130	100
3889	120x40x55	15	4	120x80x130	80
6010	-	-	-	-	-
6020	-	-	-	-	-
7010	-	-	-	-	-
7020	-	-	-	-	-
7021	-	-	-	-	-
7022	-	-	-	-	-
8010	120x40x55	20	4	120x80x130	100
8020	120x40x55	20	4	120x80x130	100
99-200	40x20x20	2,5	36	120x80x140	110
99-300	48x29x25	6,7	15	120x80x145	110

ООО «ТИ-СИСТЕМС» ИНЖИНИРИНГ И ПОСТАВКА ТЕХНОЛОГИЧЕСКОГО ОБОРУДОВАНИЯ

Интернет: www.tisys.ru www.tisys.kz www.tisys.by www.tesec.ru www.ти-системс.рф

Телефоны для связи: +7 (495) 7774788, 7489626, 5007154, 55, 65

Эл. почта: info@tisys.ru info@tisys.kz info@tisys.by